

# Caliper Maintenance and Troubleshooting

Webb Air Disc Brakes

**WEBB**  
**ULTRA**  
**GRIP™**



**WEBB®**

**Your Wheel-End Experts**

[www.WebbADB.com](http://www.WebbADB.com)



A Marmon | Berkshire Hathaway Company

# INTRODUCTION

<b>Contents</b>	<b>Page</b>
Glossary .....	3
Webb Caliper Service Kits.....	4
<b>Maintenance: Regular Checks</b>	
Brake Pad Wear .....	5
Corrosion .....	5
Brake Rotor .....	5
<b>Maintenance: Operational Checks</b>	
Adjuster Function .....	6
Caliper Sliding.....	7
Guide Sleeve Bushings .....	7
<i>Sealing Components</i>	
Guide Sleeve Boots .....	8
Tappet Boots.....	8
Adjuster Cap.....	8
Pad Replacement.....	8-9

<b>Contents</b>	<b>Page</b>
<b>Troubleshooting</b>	
Check When Replacing Calipers.....	10
Air Chamber Issues .....	10-11
Guide Sleeve Troubleshooting .....	12
Tappet Head Troubleshooting .....	13
Guide Sleeves Fully Sealed NS225.....	14
<b>Key Inspection Points .....</b>	<b>16</b>

## Symbol Legend



Please pay special attention to instructions in RED.

## Caliper Identification

MC225 both bolts visible

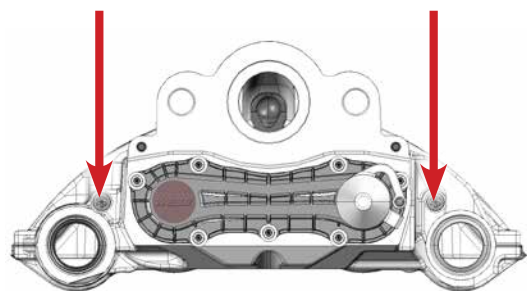

NS225: No bolts

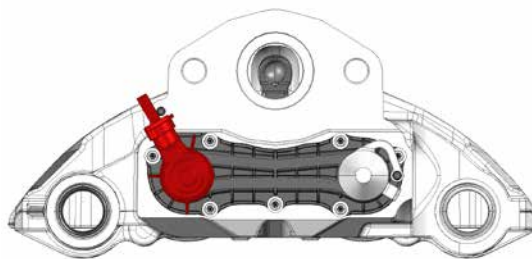

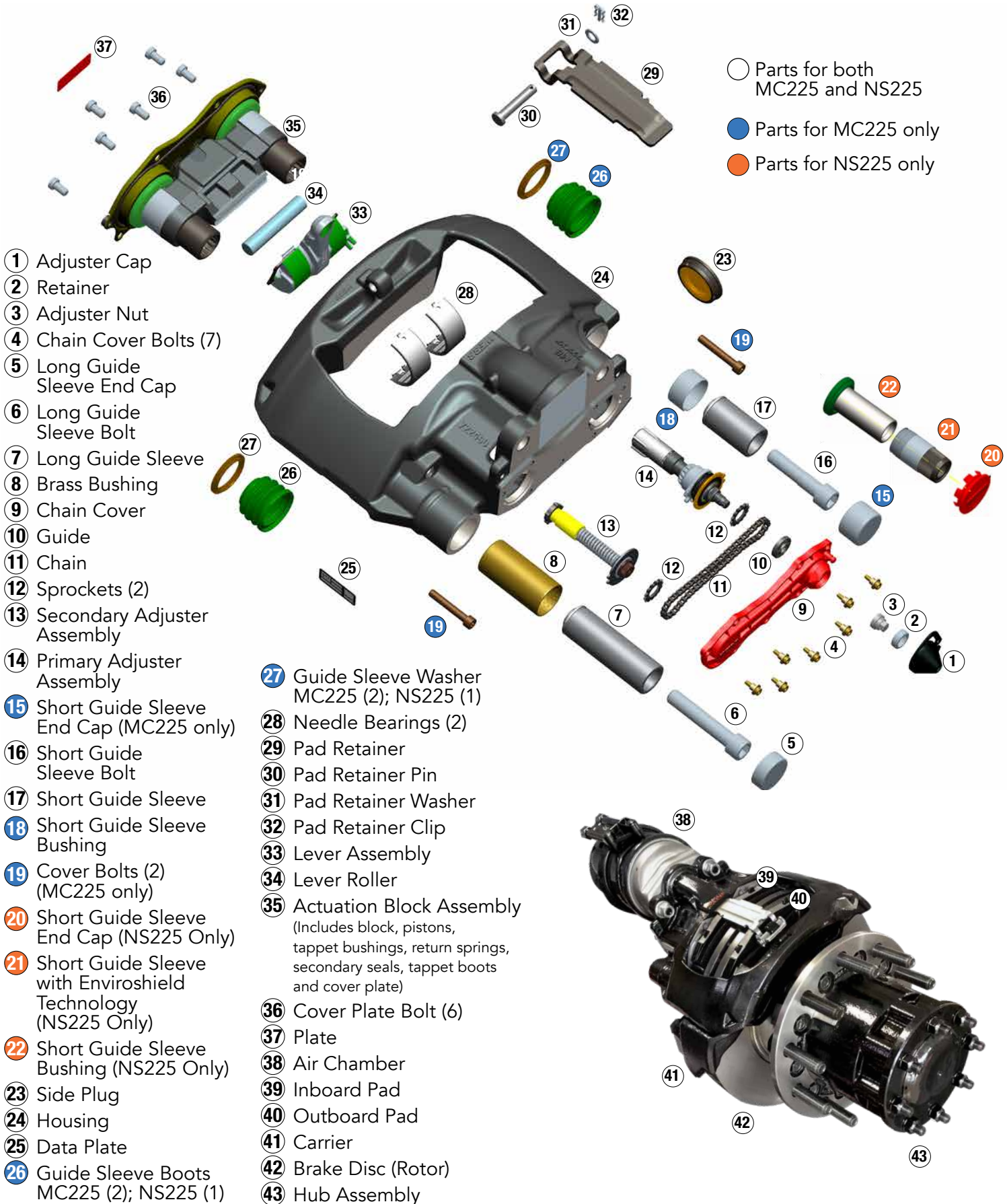

- ① Adjuster Cap
- ② Retainer
- ③ Adjuster Nut
- ④ Chain Cover Bolts (7)
- ⑤ Long Guide Sleeve End Cap
- ⑥ Long Guide Sleeve Bolt
- ⑦ Long Guide Sleeve
- ⑧ Brass Bushing
- ⑨ Chain Cover
- ⑩ Guide
- ⑪ Chain
- ⑫ Sprockets (2)
- ⑬ Secondary Adjuster Assembly
- ⑭ Primary Adjuster Assembly
- ⑮ Short Guide Sleeve End Cap (MC225 only)
- ⑯ Short Guide Sleeve Bolt
- ⑰ Short Guide Sleeve
- ⑱ Short Guide Sleeve Bushing
- ⑲ Cover Bolts (2) (MC225 only)
- ⑳ Short Guide Sleeve End Cap (NS225 Only)
- ㉑ Short Guide Sleeve with Enviroshield Technology (NS225 Only)
- ㉒ Short Guide Sleeve Bushing (NS225 Only)
- ㉓ Side Plug
- ㉔ Housing
- ㉕ Data Plate
- ㉖ Guide Sleeve Boots MC225 (2); NS225 (1)

- ㉗ Guide Sleeve Washer MC225 (2); NS225 (1)
- ㉘ Needle Bearings (2)
- ㉙ Pad Retainer
- ㉚ Pad Retainer Pin
- ㉛ Pad Retainer Washer
- ㉜ Pad Retainer Clip
- ㉝ Lever Assembly
- ㉞ Lever Roller
- ㉟ Actuation Block Assembly (Includes block, pistons, tappet bushings, return springs, secondary seals, tappet boots and cover plate)
- ㊱ Cover Plate Bolt (6)
- ㊲ Plate
- ㊳ Air Chamber
- ㊴ Inboard Pad
- ㊵ Outboard Pad
- ㊶ Carrier
- ㊷ Brake Disc (Rotor)
- ㊸ Hub Assembly

# WEBB CALIPER SERVICE KITS

**KS0200 Guide Sleeve Kit**

NS225



**KS0215 Guide Sleeve Kit**

NS225

Enviroshield Technology



**KS0205 Guide Sleeve Kit**

MC225



**KS0400 Tappet Boot Kit**

MC225, NS225



**KS0130 Pad Retainer Kit**

MC225



**KS0120 Pad Retainer Kit**

NS225



**KS0140 PWWI Pin**

NS225



**KS0300 Plain Chain Cover Kit**

NS225, MC225



**KS0340 Stepped Sensor Fitted**

NS225

(Use with screw-on or clip-on connectors)



**KS0350 Adjuster Cap Kit**

MC225, NS225



**KS0500 Cap & Grease Kit**

NS225



**KS0505 Cap & Grease Kit**

MC225



**KS0010 Caliper Service Tool Kit**

MC225, NS225



# MAINTENANCE: REGULAR CHECKS

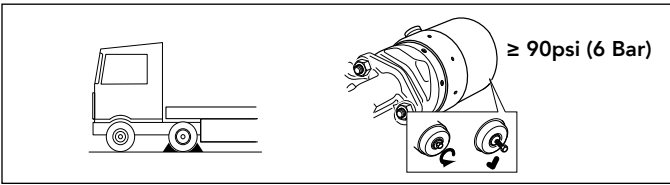

Always ensure the vehicle is securely chocked on level ground before releasing the parking brake. Cage the spring brake or use a minimum hold off pressure of 90 psi (6 bar).

Regular brake inspection is an important part of vehicle maintenance and should take place every 3 months.

**!** These check frequencies are a minimum and depending on the vehicle application, more frequent checks may be necessary. Also refer to vehicle manufacturer's instructions with regard to check frequencies and service intervals for brake calipers, brake pads, brake rotors and air chambers.

## Brake Pad Wear

A visual inspection of brake pad wear should be made independent of any wear indicator fitted to the vehicle. There are two methods of carrying out a quick and simple assessment of the approximate pad life remaining without removing the wheel.

### Method 1:

Compare the position of the caliper marking X with respect to the carrier marking Y. If the positions of X and Y are similar to those shown in the right hand diagram then the brake pad and the brake rotor thickness should be checked with the wheels removed.

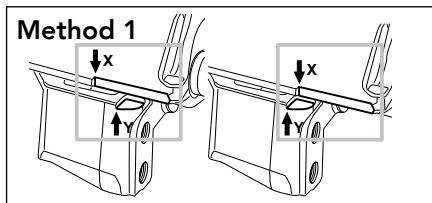

### Method 2:

Compare the position of the caliper with respect to the end of the short guide sleeve, where applicable. If dimension Z is less than .039" (1 mm) then the brake pad and the brake rotor thickness should be checked with the wheels removed.

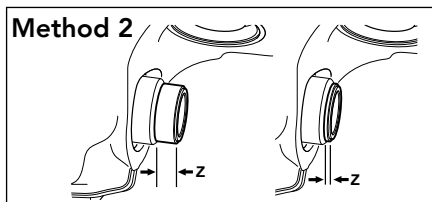

If the visual inspection indicates the pads are approaching their maximum wear allowance then a full check with wheels removed should be made. Brake

pads must be replaced when the lining material (Dimension C) is worn less than .079" (2mm).

**!** You must always replace the brake pads on both brakes across an axle.

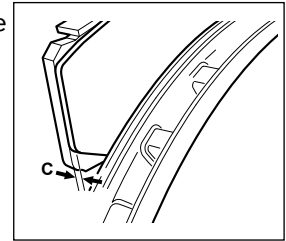

## Corrosion

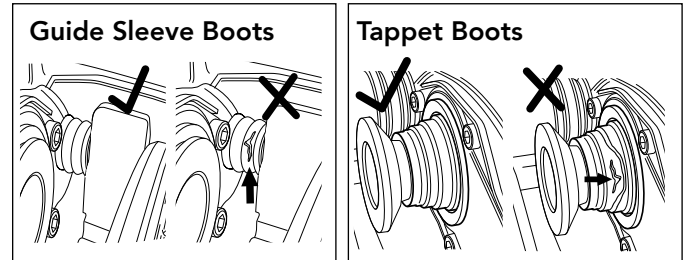

Visually inspect the caliper and carrier for damage or corrosion, paying particular attention to the guide sleeve boots and tappet boots. Check that the adjuster cap is correctly fitted. If any of the components are damaged follow the additional checks in this maintenance procedure and if necessary, replace any damaged parts using the relevant Webb ADB service kit.

## Brake Rotor

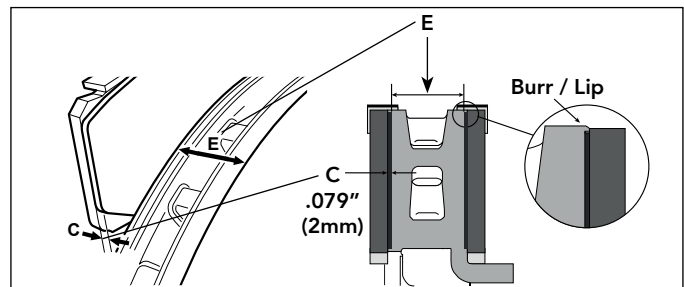

Measure the thickness of the brake rotor at its thinnest section. The brake rotor should be replaced when the minimum thickness reaches the rotor manufacturer's recommended minimum thickness.

- !** Be aware of possible burrs or lips at the outer edge when checking the rotor thickness.
- !** The brake rotors should be checked according to the vehicle manufacturer's specification, looking for signs of heavy grooving, cracking or corrosion.

If rotor thickness E is less than 1.54" (39mm), it is recommended the rotor be replaced when the brake pads are changed.

**!** You must always replace the brake rotors on both wheels across an axle. Ensure old brake pads and rotors are disposed of in accordance with local environmental regulations.

# MAINTENANCE: OPERATIONAL CHECKS

Operational checks should be carried out annually or at every pad replacement. It is important to check the brake adjuster is functioning correctly and that the caliper slides smoothly over its full range of travel.

## Adjuster Function

Ensure that service brake and parking brake are in the released condition – always ensure the vehicle is securely chocked before releasing the parking brake. Push and pull caliper 3 times in an axial direction to assess the running clearance between pads and rotor. If the caliper does not move then check the condition of the guide sleeve bushings.

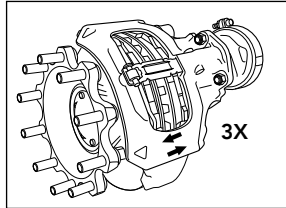

Remove the adjuster cap and fit new pads. Set the running clearance to .05" (1.3mm) by turning the adjuster with a 10mm socket or wrench (tighten the adjuster then back off 3 clicks).

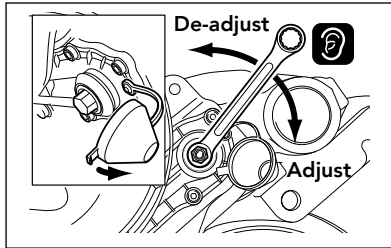

Ensure there is no clearance between the tappet heads and inboard pad.

**⚠ Never exceed a maximum torque of 18 ft.-lbs. (25 Nm) in either direction, and never use power tools.**

**⚠ Note that when turning the adjuster counter-clockwise a noticeable clicking should be heard and felt.**

Apply the brakes 20 times with 30psi (2 bar) maximum pressure. Measure the clearance between each tappet head and the inboard pad backplate – this should be measured over the whole surface of both tappet heads simultaneously using two feeler gauges.

The running clearance between each tappet head and inboard pad backplate must measure between .024" (0.6mm) to 0.047" (1.2mm). If the difference between the running clearance at each tappet head is more than .01" (0.24mm), then check the condition of the guide sleeve bushings.

If the running clearance is bigger than .047" (1.2mm) then the adjuster must be checked as follows:

- Turn the adjuster counter-

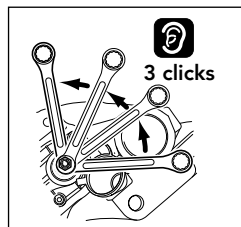

clockwise by 3 clicks to increase the running clearance.

- Position a 10mm socket or wrench onto the adjuster as a visual aid (see right), ensuring there is sufficient clearance for it to move freely.

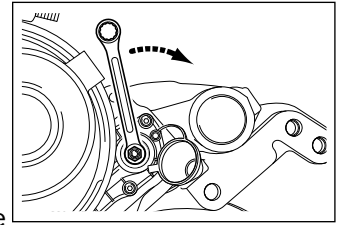

- Apply the brake 5 to 10 times 30psi (2 bar) maximum pressure and the socket or wrench should turn clockwise in small increments (as viewed from the air chamber side). Note that as the number of brake applications increase, the incremental movement of the socket or wrench decreases.
- If the socket or wrench does not turn, or turns only with the first brake application, or turns forward and backward with every application, then there is a problem and the caliper must be replaced.

If the running clearance is smaller than .024" (0.6mm) then the caliper must be checked as follows:

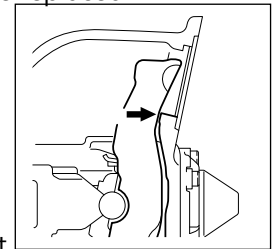

- Remove the air chamber and check that the lever is in contact against the caliper housing (see arrow).
- Remove the brake pads and if necessary, remove dirt from the brake pads, carrier & caliper:
  - Check the brake pads for wear from the tappet heads. If necessary replace the brake pads.
  - Check for wear of the pad contact areas of the carrier and if necessary replace the carrier.
  - Check the brake rotor for wear or damage and if necessary replace the rotor.
- Check that the caliper slides smoothly over its full range of travel (see Caliper Sliding check).
- Refit the brake pads and the air chamber. Repeat the adjuster function check. If the running clearance is still smaller than .024" (0.6mm) then the caliper must be replaced.

**⚠ If the running clearance is too big there is a risk of reduced brake performance and brake failure. If the running clearance is too small there is a risk of overheating and subsequent damage.**

**⚠ Opening the caliper or removing the adjuster will invalidate the warranty.**

# MAINTENANCE: OPERATIONAL CHECKS

## Caliper Sliding (NS225 & MC225)

Ensure that the service brake and parking brake are in the released condition – always ensure the vehicle is securely chocked before releasing the parking brake.

Push and pull the caliper by hand in an axial direction. If the caliper is not sliding, check the guide sleeve bushings and sealing components.

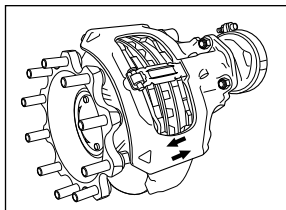

**!** Take care not to trap fingers when sliding the caliper.

For the open short guide sleeve caliper (NS225 Only), clean the protruding area of the guide sleeve from outside the caliper. If necessary, remove any light corrosion using an abrasive cloth, then lightly apply grease (ref: KA1500) to the guide sleeve. For a list of service kits that contain the grease and other genuine components see page 4.

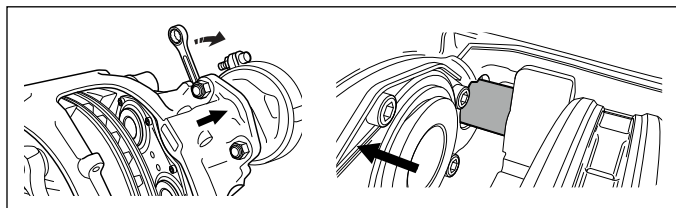

Remove the brake pads and fully wind back the tappets using a 10mm socket or wrench. Push the caliper inboard toward vehicle center. For the open short guide sleeve variant (NS225 only), clean the guide sleeve from the inner area of the caliper, then lightly apply grease to the guide sleeve. For a list of service kits that contain the grease and other genuine components see page 4.

Both NS225 & MC225 calipers must slide freely

along the whole length of the guide sleeve, with movement greater than 1" (25mm) when the pads are not present. If the caliper does not move at least 1" (25mm), then inspect the guide sleeve sealing components.

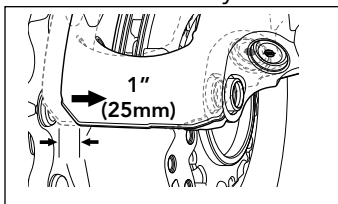

## Guide Sleeve Bushings

Remove the pad retainer by first removing the spring clip and washer.

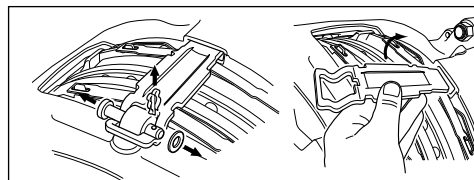

Then, depress the pad retainer to remove the pin. If necessary remove any pad wear indicator cable and clips (making note of the cable arrangement for re-fitting).

**!** Depending on the orientation of the caliper the brake pads could fall out when removing the pad retainer.

Remove the brake pads and replace with a pair of new pads to locate the caliper in the correct position in relation to the carrier. If the guide sleeve bushing clearance check is not taking place during a brake pad replacement, the relative positions of the assembled pads must be noted so that they can be re-assembled in the same relative positions.

**!** The easiest time to check this is when changing pads.

Fasten a magnetic dial indicator to the carrier on the short guide sleeve side of the caliper and use the casting feature A on the caliper as the measurement point.

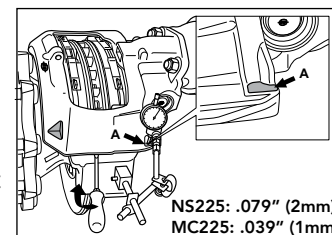

Push the caliper in the direction of the carrier and set the dial-gauge to zero. Place a suitable tool (i.e. screwdriver) centrally between the carrier and the caliper. Lever them in opposite directions, using light hand force, to read the maximum value of the bushing clearance on the dial gauge.

If the measured bushing clearance exceeds the given maximum value of .079" (2mm) for NS225 or .039" (1mm) for MC225, then the guide sleeve bushings need to be replaced using the relevant Webb service kit.

If the clearance check is not taking place during a brake pad replacement, the new pads should be removed and the original brake pads fitted in their previously noted positions. Adjust the running clearance by turning the adjuster clockwise until the pads come into contact with the disc – do not exceed 18 ft.-lbs. (25 Nm) while doing this. Turn the adjuster back counter-clockwise 3 clicks and check the pad-to-disc running clearance. Re-fit the adjuster cap, pad retainer, and any pad wear sensor components.

# MAINTENANCE: OPERATIONAL CHECKS

## Sealing Components

### Guide Sleeve Boots

On NS225 type calipers only the long guide sleeve is sealed with an inner boot and a protective cap.

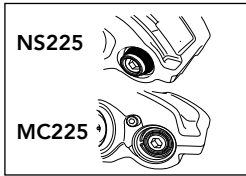

Note: NS225 calipers purchased after July 1, 2019 will be supplied with Webb's Enviroshield Technology which offers a fully sealed short guide sleeve design (See page 14 for additional details).

On MC225 type calipers the short guide sleeve is also sealed with an inner boot and a protective cap.

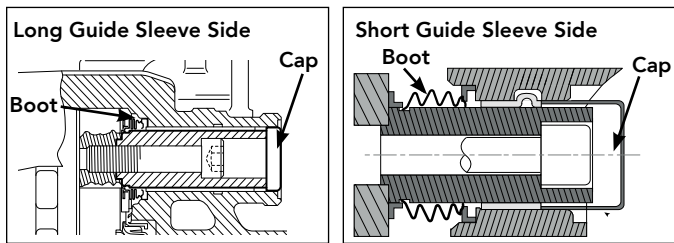

Inspect the protective caps for correct fitment and any signs of damage. Remove the brake pads to inspect the condition of the guide sleeve boots. If the guide sleeve boots or caps are damaged, replace them using the relevant Webb service kit.

### Tappet Boots

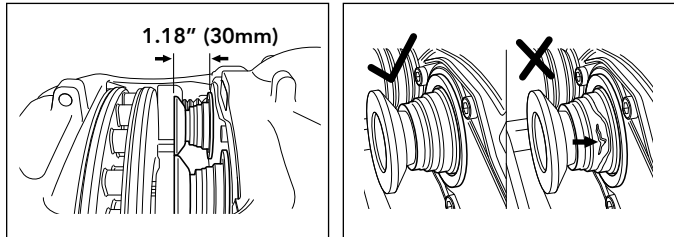

With the brake pads removed, adjust the tappets using a 10mm socket or wrench on the adjuster until the boots are clearly visible. The tappets must not be extended more than 1.18" (30mm).

Inspect the condition of the tappet boots. If the tappet boots are damaged, replace them using the relevant Webb service kit.

Check for correct fitment and condition of the adjuster cap.

**!** A little rotational free play of the tappet head is normal and a good indication that the sealing is intact.

### Adjuster Cap

If the cap is damaged or missing replace the adjuster cap using the relevant Webb service kit.

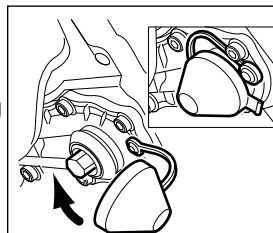

## Pad Replacement

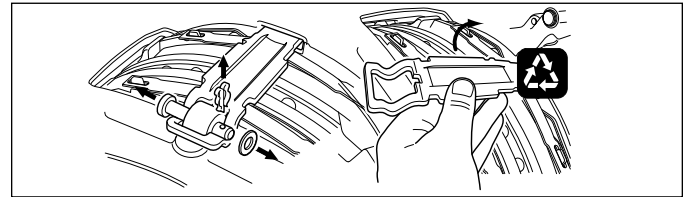

Remove the wheel (referring to the vehicle manufacturer's recommendations). Remove the pad retainer by removing the spring clip and washer, then depress the pad to remove the pin. If necessary, remove any pad wear warning indicator (PWWI) cable & clips (note the cable arrangement for fitting a new PWWI).

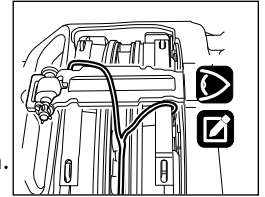

**!** Depending on the orientation of the caliper the brake pads could fall out when removing the pad retainer.

Remove the adjuster cap. Fully wind back the tappets, using a 10mm socket or wrench, by turning the adjuster counter-clockwise as viewed from the air chamber side.

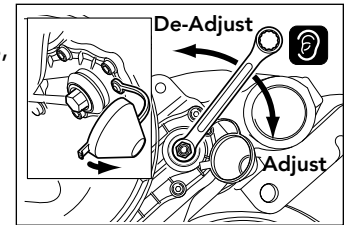

**!** Never exceed a maximum torque of 18 ft-lbs (25 Nm) in either direction, and never use power tools.

**!** Note that when turning anti-clockwise a noticeable clicking can be heard & felt.

Remove the worn brake pads and then check the caliper sliding. Note that the geometry of the MC225 brake requires that the caliper is pulled towards the outboard side first in order to remove the outboard pad. Then, push towards the inboard.

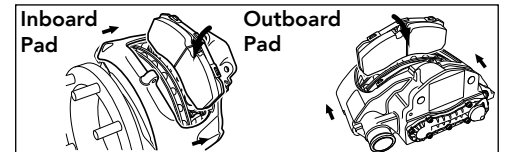
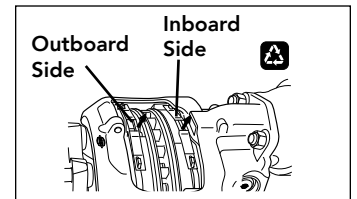

Check the rubber boots and replace if necessary. If required, clean the pad abutments of the carrier ensuring not to damage the rubber boots. Ensure the brake rotor thickness is greater than the rotor manufacturer's recommended minimum thickness. (Continues next page)



# MAINTENANCE: OPERATIONAL CHECKS

## Pad Replacement (Continued)

Inspect the rotor for signs of grooving, cracking, or corrosion. Fully wind back the tappets using a 10mm socket or wrench by turning the adjuster counter-clockwise and install the new brake pads. Note that the geometry of the MC225 brake requires that the caliper is pushed towards the inboard side to fit the inboard pad. Then, pull the caliper towards the outboard side to fit the outboard pad.

**!** You must always replace the brake pads on both brakes across an axle. Ensure old brake pads are disposed of in accordance with local environmental regulations.

Turn the adjuster clockwise until the pads come into contact with the disc – do not exceed 18 ft-lbs (25 Nm) torque. Turn back the adjuster counter-clockwise 3 clicks and check the pad-to-disc running clearance – there should be free rotation of the disc. Refit the adjuster cap.

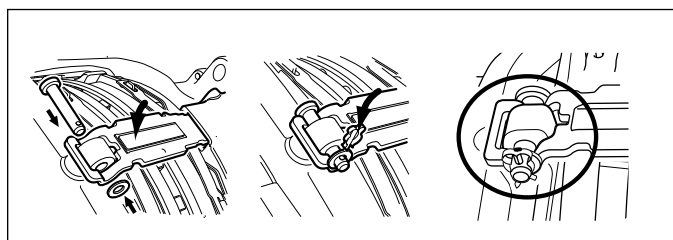
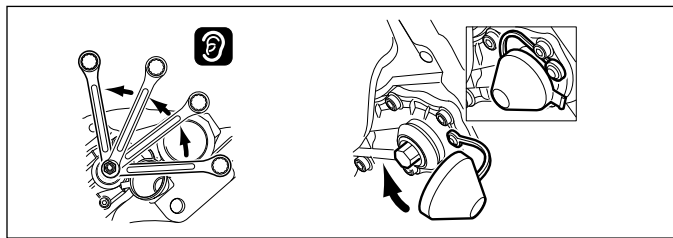
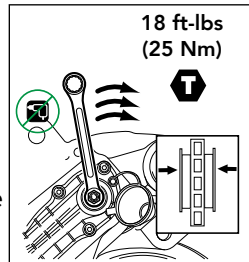

Locate the new pad retainer in the slot in the caliper and depress to enable the insertion of the pad retainer pin. Locate the washer over the pad retainer pin, then press the clip through the pad retainer pin to secure.

**!** It is recommended that pad retainer pin, where possible, is installed with pin head upright.

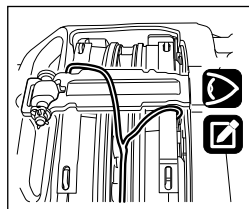

If applicable, fit a new pad wear warning indicator (PWVI) cable & clips in the same orientation as they were removed.

Replace the wheel according to the vehicle manufacturer's recommendations. Uncage the spring brake and apply the parking brake prior to removing the chocks from the vehicle. After releasing the parking brake, apply the brake 10 times then road test the vehicle to bed the pads and check the brake performance.

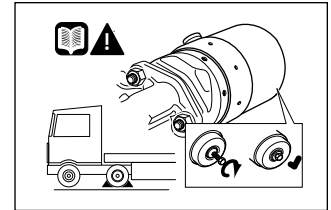

**!** Remember that there may be a lower performance during the bedding-in phase of the new brake pads.

# TROUBLESHOOTING

## Check When Replacing or Servicing Calipers



1 Check for signs of water damage on the air chamber pushrod.



2 Check for rust on the lever of the caliper being replaced.

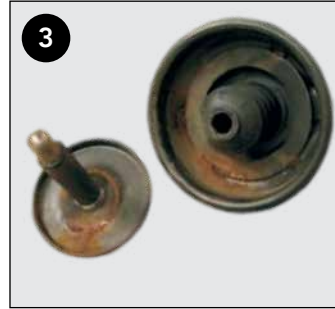

3 Damaged air chamber boots will cause water ingress to the caliper.

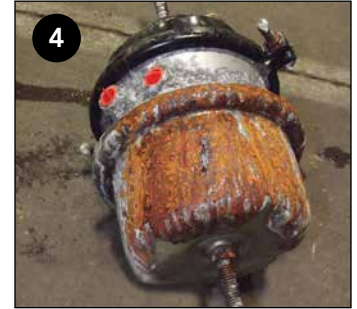

4 Check the age and condition of the chamber. A new caliper will not resolve issues caused by a failing air chamber.

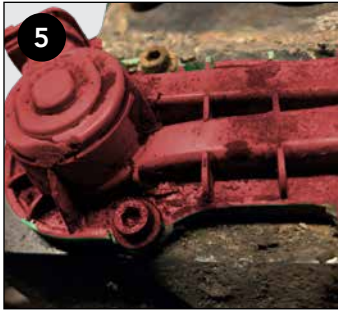

5 If an electrical fault was recorded check for damage to the chain cover of the caliper being replaced.



6 A major cause of caliper failure is due to water entry into the mechanism. 2ml of water is enough to prevent the caliper from functioning properly.



7 Check the general condition of the carrier and clean if required. Ensure the pads are sitting correctly in the carrier.



Further information, Installation and Maintenance Guides, Video Guides and Tool Kit User Guide are all available at [webbADB.com](http://webbADB.com)

## Air Chamber Issues

Even with well established ADB servicing practices, water ingress to the caliper remains an issue for many end-users. Many of these cases are due to water ingress through the air chamber.

Air chambers have a pressure side and non-pressure side. The non-pressure side (closest to the caliper) has to be vented to the atmosphere, which can allow water into the caliper if the pushrod sealing boot is not properly sealed. This is not an issue on a drum brake setup as the pushrod is detached from the internals of the brake. If this seal is damaged or ineffective, the brake will quickly become permanently damaged (through corrosion).

Note the face sealing point and pushrod sealing point in the layout of air chamber parts at right.

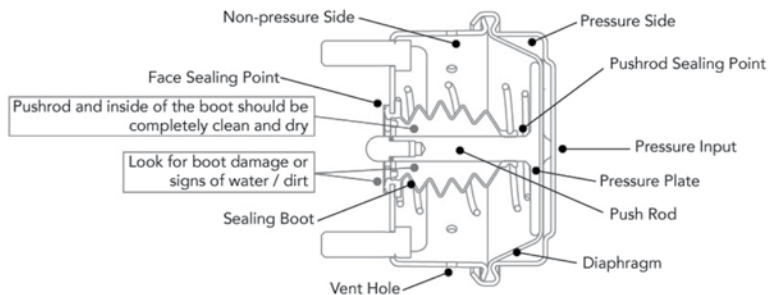

## Air Chamber Troubleshooting

### Preventing Water Ingress

When fitting an aftermarket caliper to a truck, how does the mechanic determine if the air chamber is still serviceable? Checking that the pushrod operates correctly with no air leaks at the diaphragm is only one part of the process. The mechanic must also ensure that the caliper is not subject to water ingress through the air chamber by checking the push rod boot/seal:

**1** First check the flange seal that is visible on the air chamber mounting face. The protruding seal should be at least .12" (3mm) proud of the non-pressure chamber (air chamber body), and without any damage or nicks.

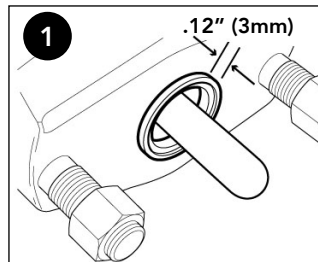

**2** After checking the flange seal, carefully inspect the visible part of the pushrod. If water or rust staining is present on the pushrod, it is a clear sign that the pushrod seal/boot has split or is not seating correctly.

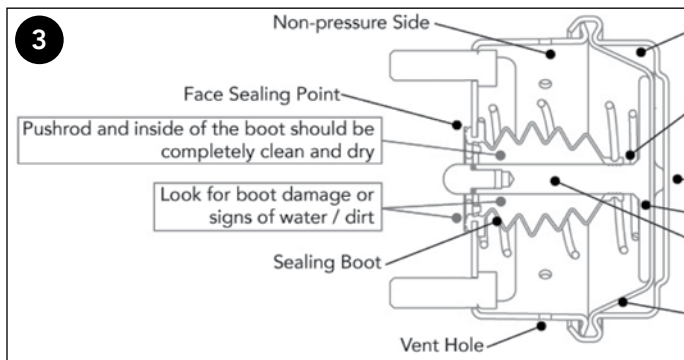

**3** Next, examine the pushrod and the inner part of the seal for any damage or evidence of water entry through the boot. (See boxes in the top diagram.) It is difficult to see fully inside the boot, but a flashlight will help. Remember, if the pushrod shows signs of corrosion (after wiping away any grease), boot damage is the likely cause.

If water or rust staining is present on the pushrod (photo at right), it is a clear sign that the pushrod seal/boot has split or is not seating correctly.



The inside of the boot and the pushrod should look like the image at right.



Following the steps above will help preserve the life of calipers on trucks, trailers and buses.

The caliper and service chamber interface is often overlooked, but it is always worth taking a few minutes to check the seal carefully to determine if a new air chamber is needed or not.

### Illustrations



*This brake faulted after less than two weeks of service. Water entered through the air chamber seal, which created an electrical fault. The issue was highlighted as a "worn-out pad" signal in the cab.*



*A leaky air chamber seal caused water ingress that damaged this brake beyond repair.*

# TROUBLESHOOTING

## Guide Sleeve Troubleshooting

As a vital part of the braking function worn or seized guide sleeves have severe effects on brake pad and disc wear. This can lead to overheating with severe consequences to wheel end components, which will most likely lead to a vehicle breakdown.

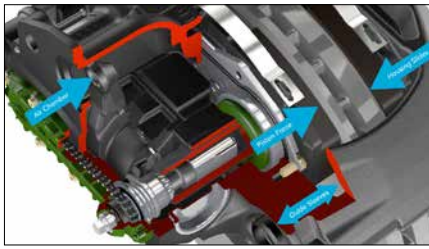

### How to check

- 1 If sliding becomes stiff or seized, the first effect will be the outboard pad showing signs of higher wear than the inboard pad, and the brake will run hotter than normal – heat marks or blue spots may be seen on the disc.
- 2 During the vehicle's regular inspection, try to get a feel for the condition of the caliper guide sleeves. Standing in the inspection pit, and with the park brakes released (make sure the vehicle is chocked and safe!), the mechanic can apply force to move the air chamber/caliper on the guide sleeves. If the caliper can be moved easily the pins are not seized, while if it is stiff then further investigation will be needed.



### Maintaining Your Guide Sleeves

- 1 During the regular vehicle inspection, always inspect the guide sleeve boots and tappet boots for mechanical damage or heat damage. They are silicon rubber and are tough, but it is possible for debris to damage the boots. If the guide sleeve boots are heat damaged, this may be a sign that the caliper is not sliding correctly. If there is any damage to the boots, then they must be changed with a new, good quality, guide sleeve repair kit.
- 2 So long as no water or dirt is entering the guide sleeves, they should last a long time, but they are serviceable items due to the vibrational load that they experience. If they remain free from seizure then they may become worn after time and need to be changed. The Webb ADB maintenance instructions give guidance on how much clearance is allowed before bushings/sleeves need changing.



- 3 An open guide sleeve with a rubber bushing is fitted to some calipers, and these can become clogged with dirt or debris in certain applications. Webb ADB just released a fully sealed short guide sleeve on its NS225 type calipers to further improve life and reliability for these applications.

### Changing The Guide Sleeve System

- 1 Service issues can be caused by incorrectly fitted guide sleeve protection caps – they can be tricky to fit without the correct tool. If you don't have a purpose made protective cap fitting tool, ensure that you use a metal drift that fully covers the surface of the cap, and that you can hold it square. If the cap is not parallel, and fitted to the correct depth, there is a risk of water ingress which will cause the guide sleeves to seize.
- 2 When fitting the guide sleeve protective caps, always ensure that the guide sleeve boot is in the compressed (new pad) condition, otherwise the caliper movement may be limited after fitting the cap.
- 3 After ensuring the sealing bead of the guide sleeve boot is correctly seated in its groove (on the guide sleeve), it is important to make sure the white plastic washer is correctly fitted onto the boot – this keeps the bead seated in the guide sleeve and without it, water ingress is likely.
- 4 When tightening the guide sleeve bolts, ensure the carrier is securely clamped in a vice at the same side of the carrier being tightened – the carrier can twist or bend (due to the high load applied when tightening the bolt) if this is not followed. If the carrier is still mounted to the axle, there is no risk. Ensure that the guide sleeve nearest the vice (left hand side of the image below) is the one torqued.
- 5 Only use the original grease supplied with the guide sleeve kit, or fitting kit. Other greases may not be compatible with the guide sleeve boot material.



## Tappet Head Troubleshooting

The pistons and tappet heads have an important function in the brake caliper as they clamp the pads to the disc, and while the tappet heads are rarely damaged, the seals behind them have to perform under difficult conditions, particularly heat and dirt.

❶ Checking the condition of the tappet seals is important during a regular vehicle inspection. The seal is difficult to inspect without removing the brake pads, therefore it may be necessary to use a flashlight to inspect the area between the inboard pad and caliper housing. The seal in ❶ has heat damage, which should be possible to detect without removing the pads. However, a tappet seal in this condition must be replaced immediately in order to prevent further damage to the brake.



❷ It is difficult to see the tappet seal if the piston is not extended. Therefore, adjust the pistons out so that the seal is fully visible. The tappets must not be extended more than 1.18" (30mm) from the front cover.

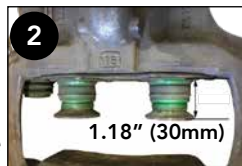

❸ If the brake has seen higher temperatures through sticking guide sleeves, it is important to check for other effects and issues caused by this. The main one is the possibility of damaged tappet boots through excessive heat.



❹ In photo at right, the primary seals have been removed from the front cover, showing an example of a damaged tappet boot (right hand). The left hand seal is OK and highlights the difference in color.



❺ After removing the damaged seal, the piston threads can be carefully cleaned with a small wire brush so long as dirt and corrosion is not excessive. However, take care to assess the condition of the secondary seal and make sure there are clean threads underneath the seal. If corrosion extends under the secondary seal, the caliper should be replaced.



❻ Tappet heads should be carefully removed with the correct service tool as damage to the piston threads will prevent the brake from being adjusted for the fitting of new pads.



❼ If necessary, remove the secondary seal to make a more detailed assessment and then replace with a new secondary seal from the repair kit.



❽ After removing the tappet seal, check the cover plate – if the sealing interface is damaged or corroded, then the caliper should be replaced. On re-assembly, lubricate the piston threads with the white grease (p/n KA1500) supplied in the tappet service kit (p/n KS0400).



❾ It is important to lubricate the face of the tappet head that touches the end face of the piston, as the piston must be free to rotate while the tappet head is static. Use black high pressure grease (p/n KA1505) supplied in the tappet service kit (p/n KS0400).



❿ Finally, for re-assembly, use the correct tool to accurately refit the tappet seal and tappet head.



⓫ Note that the tappet heads and seals can be replaced with the caliper either on or off the vehicle using the Webb ADB tool kit (see [www.webbadb.com](http://www.webbadb.com) for service instructions). Tappet Heads and seals are often overlooked and need to be part of the regular vehicle check. Ensure good quality repair kits and the correct service tools are used for the job. It is a straightforward repair, but care must be taken to fully remove any corrosion. The threads need to be fully cleaned so that the pistons wind in and out without excessive force.

## TROUBLESHOOTING

### Carrier Troubleshooting



1  
Abutments are often heavily corroded.



2  
Check for steps in the abutment that can snag the pads.

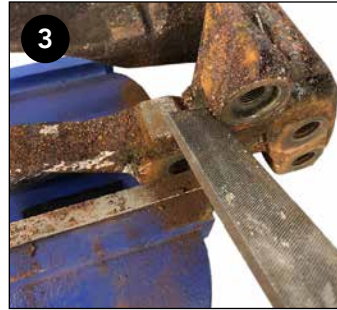

3  
Carefully clean the abutments with a wire brush, emery cloth or file - be careful not to remove the core metal.

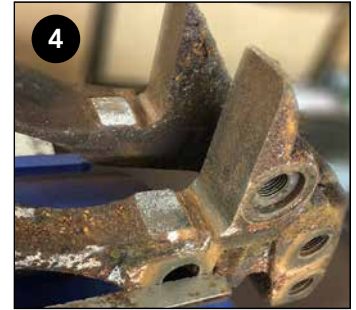

4  
If the abutments are cleaned up without steps then the carrier is ok to use.

### NS225 Calipers with Enviroshield Technology

Many calipers in the field have short guide sleeves that are not fully sealed. The guide sleeve is resistant to corrosion, but water and debris can still get between the sleeve and rubber bushing, causing excessive wear or in some cases, restriction to sliding. A sliding system that is not free to move can cause the outboard pad to drag and increase the wear rate of the friction material. In severe cases, the residual dragging can cause elevated brake temperature. Webb Wheel has addressed this issue on the latest NS225 caliper which is supplied with Enviroshield Technology. This technology provides a fully sealed short guide sleeve which is designed to offer a superior seal against water and debris intrusion.



The relieved casting and extended metal ring for fitment of a sealing boot



The extended inboard end of the rubber bushing

The first step is to assemble the guide sleeve bolt into the guide sleeve (fitting it later can be tricky, as the black rubber boot restricts the entrance); grease the sleeve with the grease provided and insert the short guide sleeve from the disc side. With the sleeve inserted into the rubber bushing, pinch the grey rubber boot between your finger and thumb, and stretch the bead into the groove of the metal ring on the end of the rubber bushing (see photo).



Make sure the bead is seated all the way round the metal ring. Following this, it's time to fit the carrier.

Tighten the bolts to 133 ft. -lbs. (180Nm) +90° and ensure the carrier is firmly clamped in a vice at the side you are tightening. Be careful not to damage the black rubber boot with the 14mm hexagon key (see photo at right).



Make sure the long guide sleeve and end cap are fitted as outlined in Webb's fitting instruction manual, and ensure the carrier remains in a position where the inner boots (green and grey) are compressed. Stretch the black boot onto the outer diameter of the short guide sleeve.



Next, place red cap in the end of the guide sleeve, but don't push it into place just yet (see below).



Slide the boot off the guide sleeve to make the bead drop into the groove in the red plastic cap.

With the boot fully located all the way round the cap, push the cap squarely and firmly, ensuring that it clicks into place in the guide sleeve.

Calipers with a fully sealed short guide sleeve (NS225 type) enables Webb calipers to fit all applications that previously ran with an open sleeve only. Vehicles operating in all conditions should benefit from the longer service life of the short guide sleeve system with the fully sealed design.

## Get the Caliper Service Tool Kit

Part Number: KS0010

### Webb MC225 and NS225 Caliper Service Kit

Tools and instructions for proper service and replacement

**Includes the service tools you need to replace ...**

- Tappet head, seal, and boot
- Short and Long Guide sleeve bushing and boot
- Short and Long Guide sleeve cover cap

[www.WebbADB.com](http://www.WebbADB.com)

**WEBB ... Your Wheel-End Experts!**

©2018 Webb Wheel Products

## Get the Webb Wheel App



Scan or go to [webbwheel.com](http://webbwheel.com)

Scroll down and choose "Mobile App" icon.

## Key Inspection Points

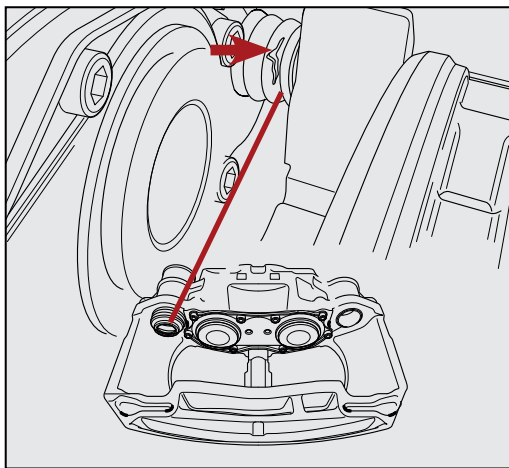

Check Guide Sleeve  
Boots for Damage

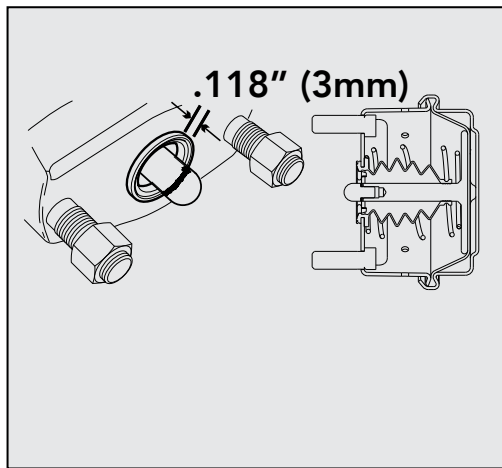

Check Air Chamber  
Seal and Boot

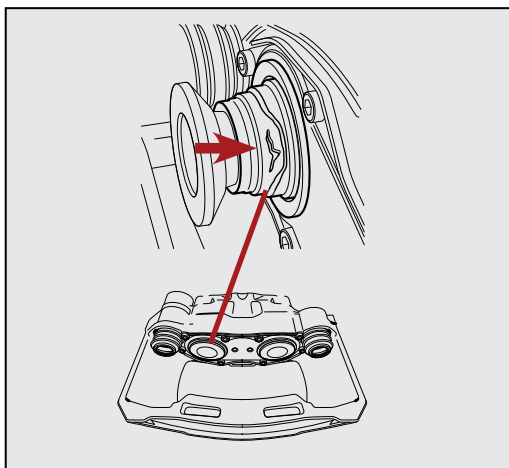

Check Tappet Boots  
for Damage

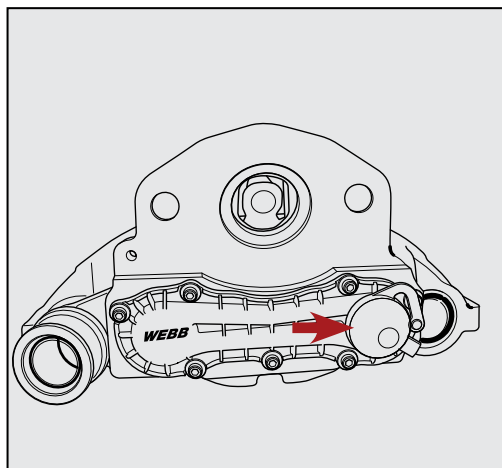

Check Adjuster Cap  
Fitting

## Your Wheel-End Experts



**AIR DISC BRAKES**

[www.WebbADB.com](http://www.WebbADB.com)

800-633-3256



A Marmon |  
Berkshire Hathaway  
Company